

Einnut-Vorhangprofil Piccolo mit «mini»-Laufnut
Rail de rideau piccolo à encastrer avec écartement «mini»

HM-104

Vorhangprofil «mini» zum Einnuten im Vorhangbrett.
Rail de rideau «mini» pour encastrer dans la planche de rideaux.

Profil.

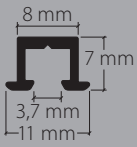
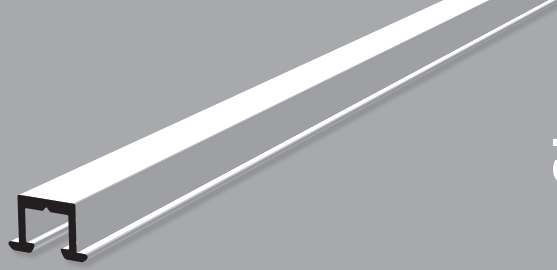

Aluminium natur eloxiert
Aluminium éloxé naturel

Aluminium weiss, Ral 9016
Aluminium blanc, Ral 9016

Lagerlängen von 6 m
Longueurs de 6 m

Zubehör «mini»
Accessoires «mini»

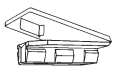

Montagezubehör
Accessoires pour fixation





Dienstleistungen
Services

Fixmasszuschnitt inkl. Ausbruch
Coupe sur mesure fixe et encoche

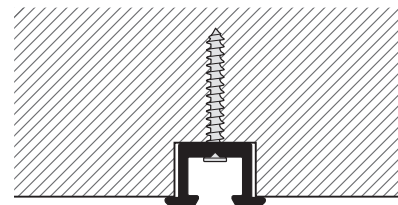
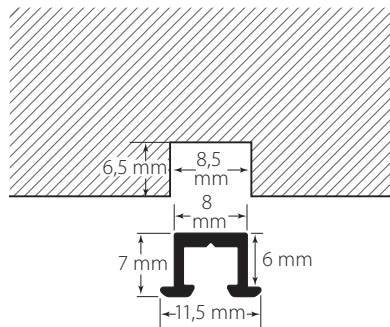
Montage
Fixation

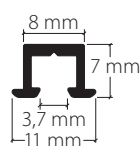
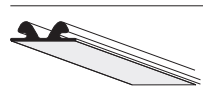

Profil ca. alle 12 cm gelocht Ø 2,5 mm
 Montage mit Center-Schrauben
Rail percé Ø 2.5 mm tous les 12 cm env.
Fixation seulement avec vis centre

	Artikelbezeichnung <i>Désignation</i>	Bestell-Nr. <i>Code de commande</i>
	<p>Einnut-Vorhangprofil «mini» Rail de rideaux à encastrer «mini» Aluminium natur eloxiert, gelocht <i>Aluminium éloxé naturel, percé</i></p>	<p>104.10</p>
	<p>Aluminium weiss, Ral 9016, gelocht <i>Aluminium blanc, Ral 9016, percé</i></p>	<p>104.20</p>
	<p>Lagerlängen von 6 m <i>Longueurs de 6 m</i></p> <p>Gips-Schutzband Kunststoff, weiss Rollen à 50 m Ruban de protection pour crépis, en plastique, blanc Rouleaux à 50 m</p>	<p>21054.20</p> <p>Zuschnitt auf Mass + 20% <i>Coupe sur mesure + 20%</i></p>
	<p>Center-Schrauben, verzinkt Vis pour rail à rideaux, zinguées</p>	<p>12 mm 13001</p> <p>15 mm 13003</p> <p>18 mm 13005</p>