

2-channel clip curtain profile with "maxi" channel, VS57 standard

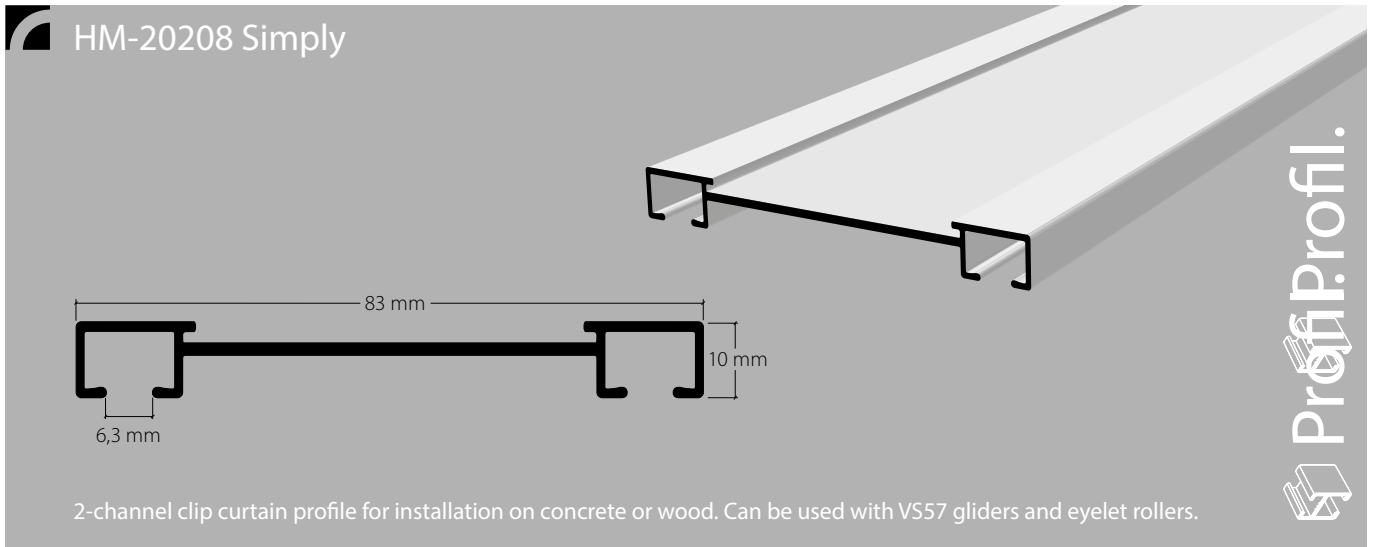

Aluminium, natural anodised

Aluminium, white, RAL 9016

Stock lengths of 4 m and 6 m

"maxi" accessories

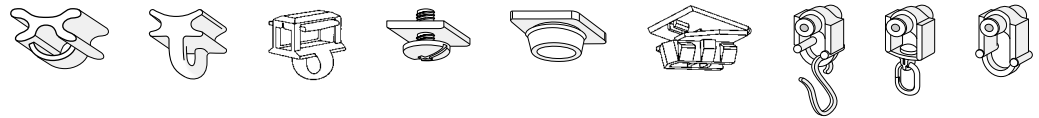

Installation accessories

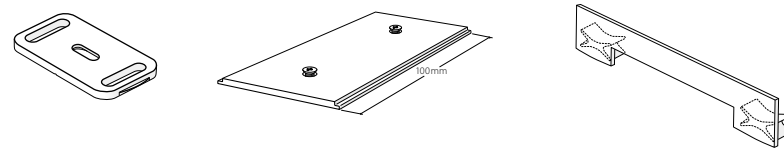

Services

Made-to-measure including opening

Bending service

This profile cannot be bent

Installation

Ceiling installation

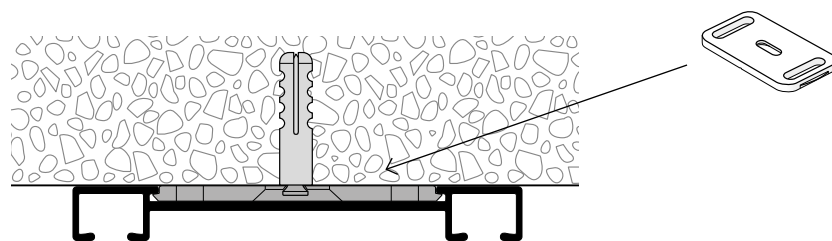

Article description

Order no.

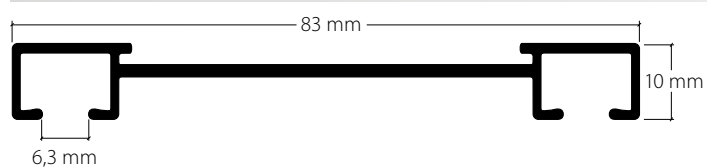

Simply ceiling curtain profile with "maxi" channel, VS57 standard
can be used with VS57 standard gliders or eyelet rollers

Aluminium, natural anodised

20208.10

Aluminium RAL 9016 white

20208.20



Stock lengths of 4 m and 6 m

Made-to-measure + 20%

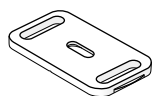
**Installation clip KL58**

for 2-channel curtain profile HM-20105 and HM-20208

plastic

21057

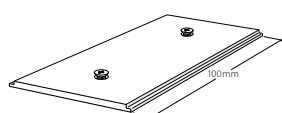
**Profile connecting plate V58**
with two threaded screws

Unfinished aluminium

21056

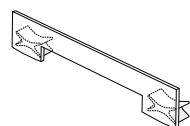

**Side cap S20208**

Plastic, grey

21017.14

Plastic, white

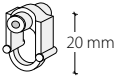
21017.20

	Article description	Order no.
	Eyelet roller, white plastic with shaft	25287
	Eyelet roller, white plastic with rotatable eyelet	25288
	Eyelet roller, white plastic with metal hook	25289