

2-channel curtain profile with "maxi" channel, VS57 standard, can be used with shadow gap strip

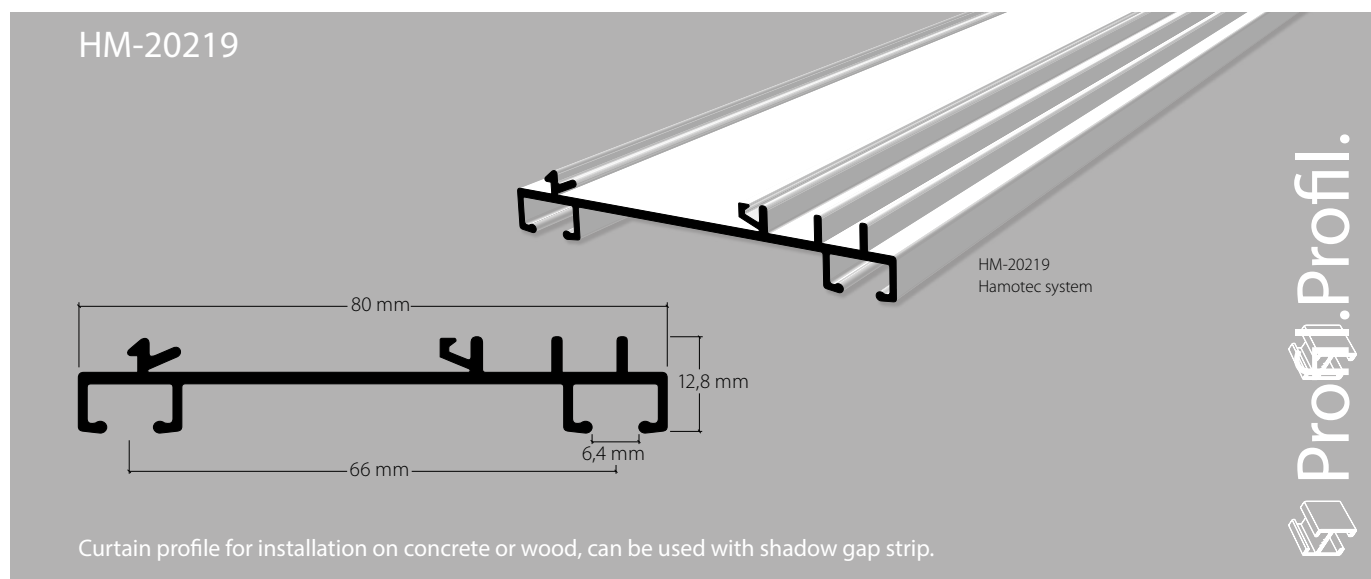

Aluminium, white, RAL 9016

Stock lengths of 4 m and 6 m

"maxi" accessories

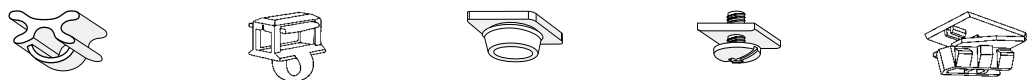

Installation accessories

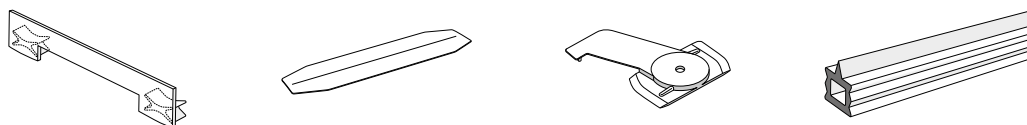

Services

Made-to-measure including opening and mitre



This profile cannot be bent

## Installation

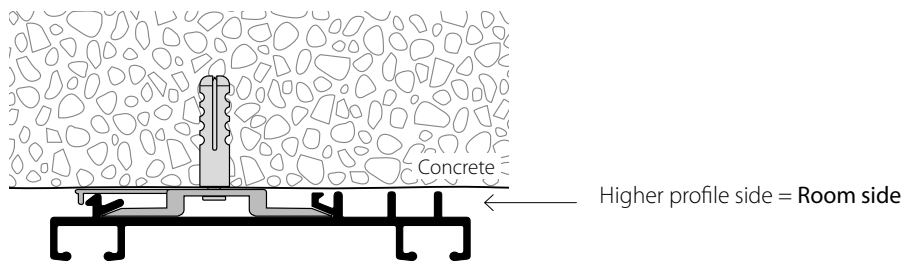

**Caution:** Opening / glider entry is only possible with "maxi" punch head.

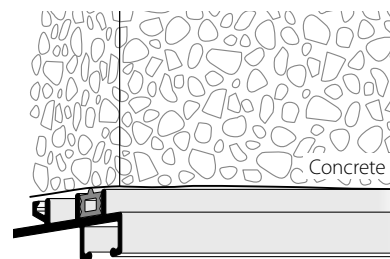
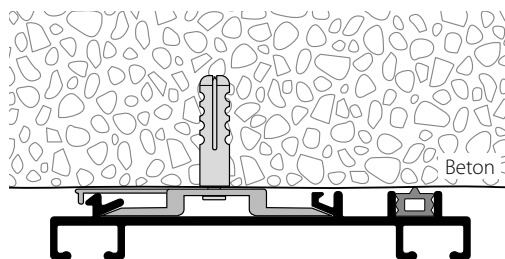

### Features:

- Excellent inherent stability thanks to rigid aluminium
- Installation with clamping bolt
- The shadow gap strip compensates for unevenness in the ceiling

Installation of clamping bolt

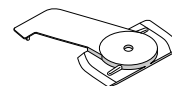

Fixings approx. every 40-50 cm

Article description	Order no.
---------------------	-----------

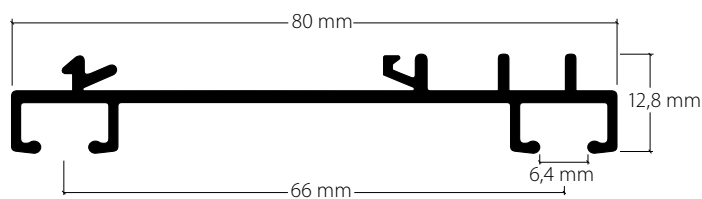

**"maxi" 2-channel curtain profile**  
for installation with clamping bolt  
can be used with shadow joint strip

Aluminium, white, RAL 9016      Other colours on request      **20219.20**



Stock lengths of 4 m and 6 m

Made-to-measure + 20%

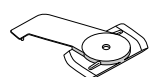

**Installation of clamping bolt SP, white plastic**      **21039.20**  
for profiles 20219, 20228



**Profile connector, spring steel**      **21028**  
for profiles 20219, 20228

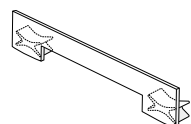

**Side cap S20219**  
Plastic, white      **21026.20**

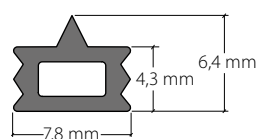

**Shadow gap strip SF 219, PVC white**      **21060.20**  
50 m rolls



Clamping bolt, plastic, prevents injuries / stripes on the ceiling when screwing in the clamp. (Hamotec development)