

Balcony curtain profile for embedding in concrete

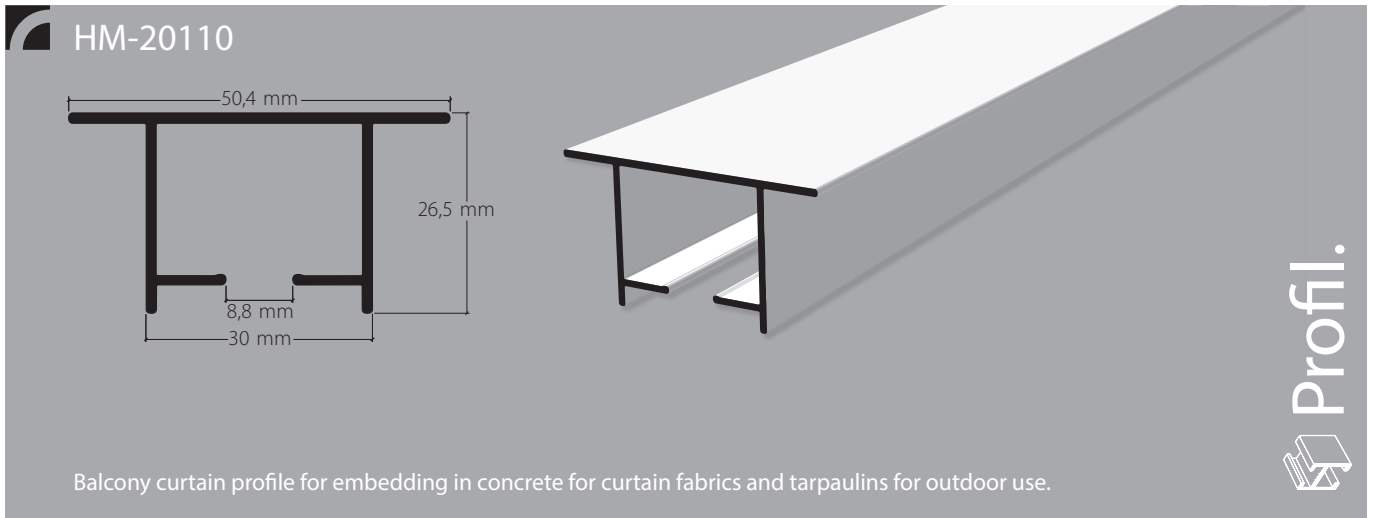

Aluminium, grey, RAL 7038

Aluminium, white, RAL 9016

Stock lengths of 6 m

Accessories

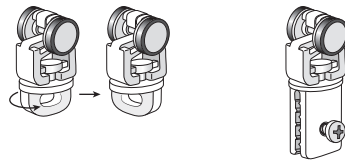

Installation accessories

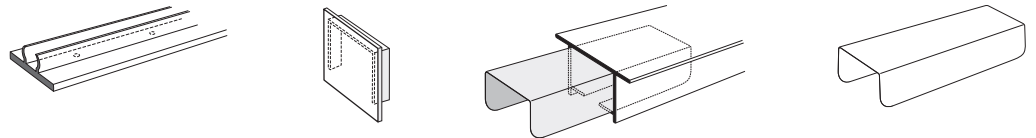

Services

Made-to-measure

Bending service

Plan view (seen from above). State room side.



Radii: from 300 mm
90° angle or angle of your choice



Non-standard radii and angles as per sketch

Installation instructions, see next page

Installation

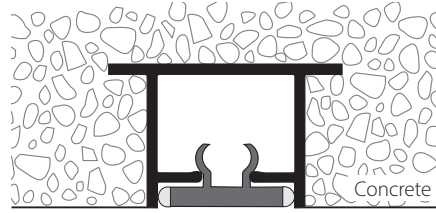
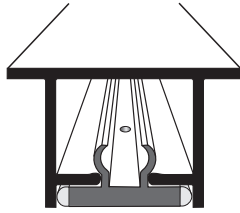

1. Treat the curtain profile HM-201 10 (HM-20115) with silicone spray.



2. Insert movable protective tape into the curve of the curtain profile.

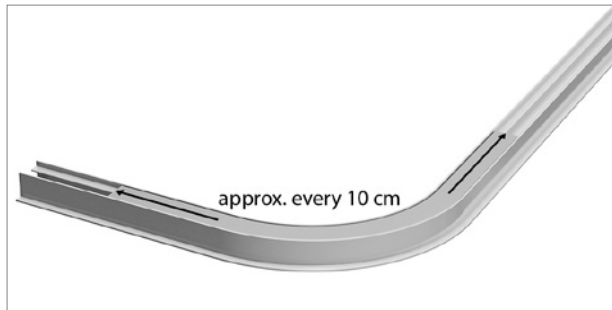

3. The protective strip should reach approx. 10 cm into the straight.

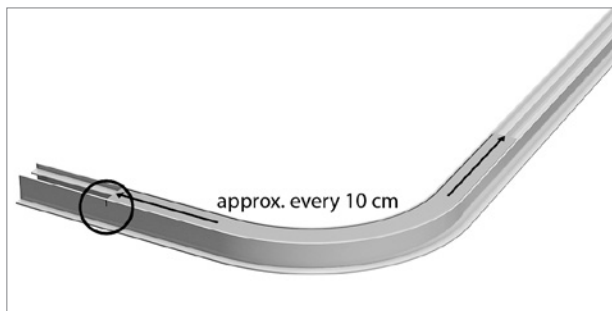

4. Mark the side of the strip end.



5. Seal the curtain profile with the side cap 21052 (HM-20115 with 21053) (to prevent the ingress of concrete water).

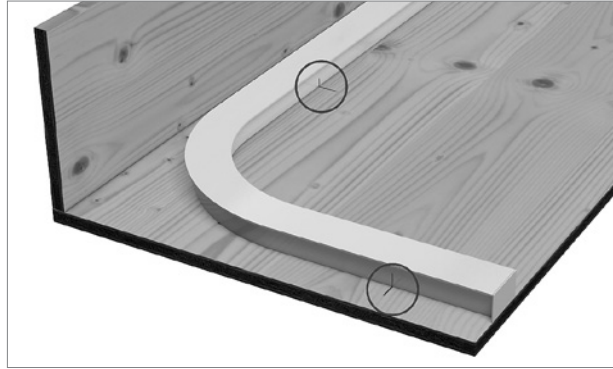

6. Adjust curtain profile to marking and mark tape end on panel.

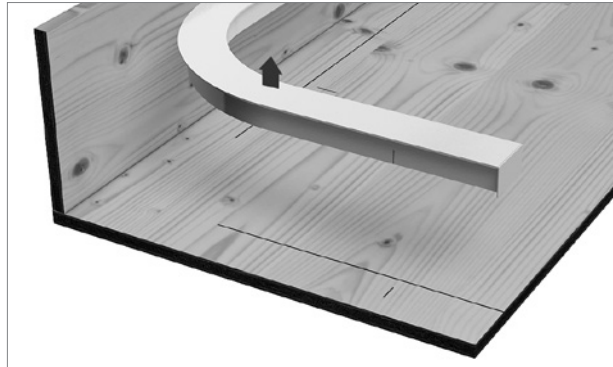

7. Remove the curtain profile once more.

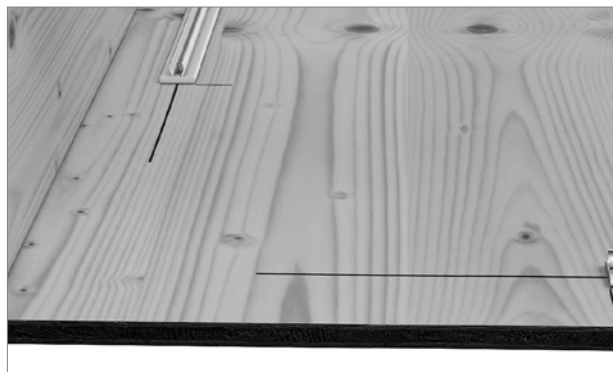

8. Fix pre-drilled installation strips to marking with Hamotec special nails.

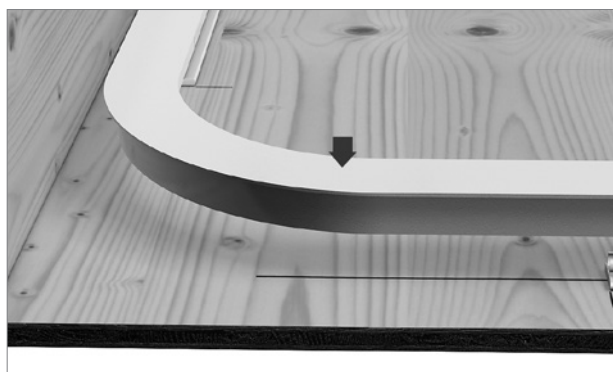

9. Clip the curtain profile onto the installation strip.

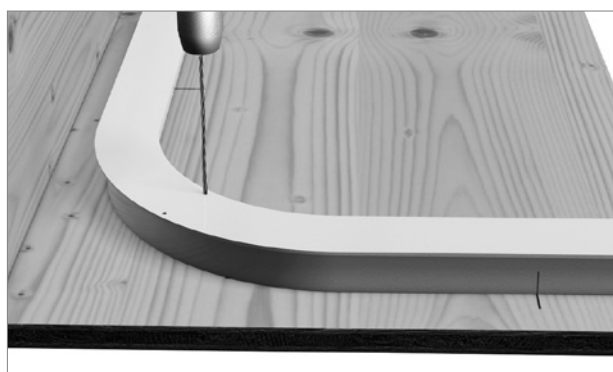

10. Drill two side holes into the curve of the profile.

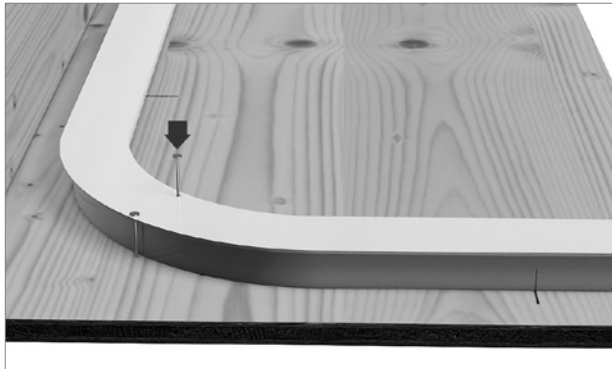

11. Fix the curtain profile to the panel using aluminium nails.

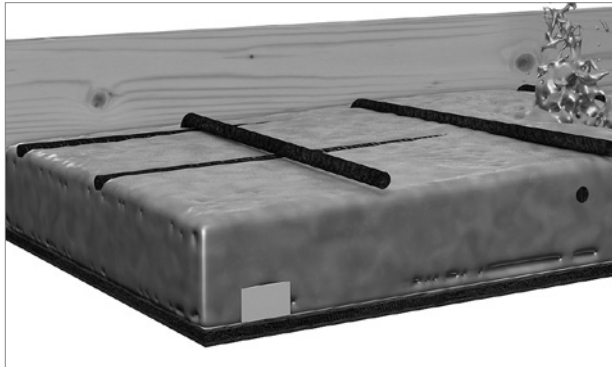

12. Concrete in the profile.

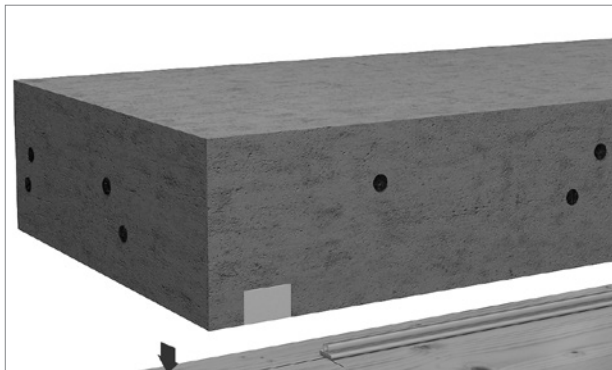

13. Remove the panel once hardened.

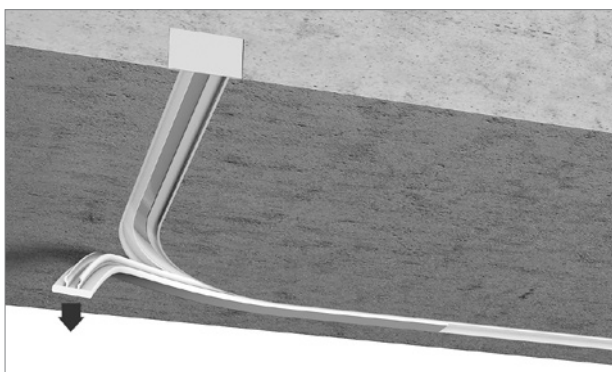

14. Remove the remaining protective strip.

Caution:

It is **essential** that you re-insert the protective strip if the ceiling still needs to be painted or use another means to protect it!

Article description	Order no.
---------------------	-----------

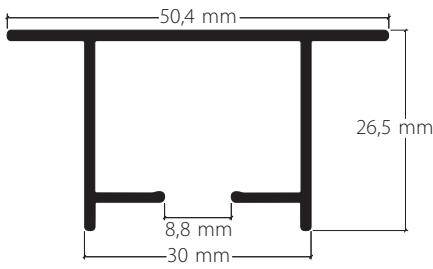

Balcony curtain profile for embedding in concrete
for curtain fabrics and tarpaulin as privacy
and sun screen

Aluminium, grey, RAL 7038

20110.11

Aluminium, white, RAL 9016

20110.20



Stock lengths of 6 m

Made-to-measure + 20%

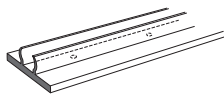

Cover strip L110, white plastic
drilled 2.0 mm

21049.20



Stock lengths of 6 m

Made-to-measure + 20%

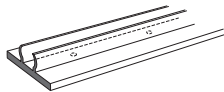

Cover strip L110, plastic SOFT
(for curved elements)
for balcony profile HM-20110 drilled Ø 2.0 mm

21049.20.W



Stock lengths of 2 m

Made-to-measure + 20%

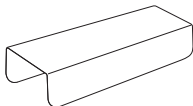





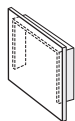

Profile connector V110, spring steel

21220

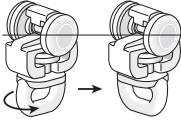

Side cap S20110, grey plastic
prevents the ingress of concrete water

21052.14

	Article description	Order no.
	Aluminium nails 3.1 x 55 mm Box contains 500 <i>Clous en aluminium 3,1 x 55 mm</i> <i>Cartons de 500 pcs</i>	991105
	Double head pin 1.6 x 24/ 35 mm	991102
	2.0 x 24/ 32 mm	991106
	2.0 x 24/ 32 mm, grooved	991107
	Locking device C110, nickel-plated iron	25200 50 pc.
	Roller with rubber cover and rotating clamping eyelet for assembly to balcony profile HM-20110 and HM-20150 Plastic, grey	21210.14
	Plastic, white	21210.20
	Eyelet roller with rotating sewn eyelet for balcony profile HM-20110 and HM-20150	21211.14
	Aluminium grey	21211.20
	Aluminium, white	Plan view (seen from above). State room side.
Bending service	 Radii: from 300 to 1000 mm	95.20110.1
	 Non-standard radii and angles as per sketch	95.20110.4